

THE INFORMATION CONTAINED IN THIS DOCUMENT IS PROPRIETARY TO Y-S ELECTRONIC, ANY REPRODUCTION IN PART OR WHOLE WITHOUT PRIOR WRITTEN APPROVAL OR AUTHORIZATION OF Y-S ELECTRONIC IS STRICTLY PROHIBITED.

RoHS COMPLIANT

| REVISIONS | | | | |
|-----------|---------|-------------|-------------|------|
| REV | ECN NO. | DESCRIPTION | APPROVED BY | DATE |
| A | | | | |

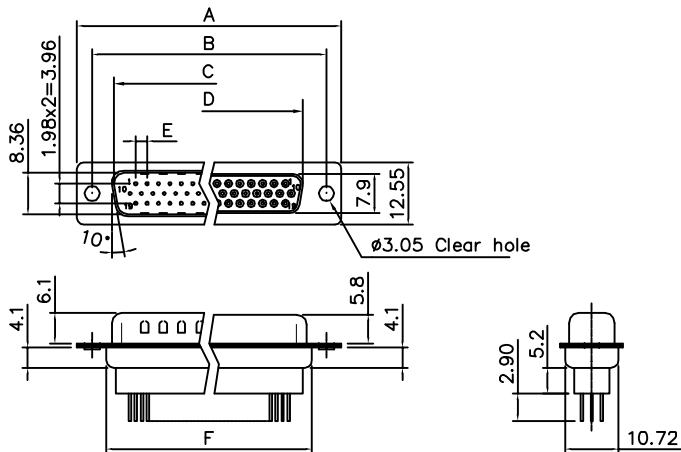

Product Specification

Material

Insulator :Glass-Filled Thermoplastic PBT,UL94V-0 rated
 Contact :Brass or Phosphor Bronze
 Shell : Steel, 100u" Tin Over 50u" min Copper
 Clinch Nut: Brass, 100u" min Nickel Plated.
 Screwlock :Brass, 100u" min Nickel Plated.

Electrical

Contact Resistance :20 milliohms
 Max at 1 AMP DC.
 Insulation Resistance :1000
 megohms at 500 VDC
 Dielectric Withstanding Voltage :
 1000 VAC/rms 60Hz for 1 minute
 Current Rating :3 AMP
 Volatge Rating :250 VAC/rms 60Hz

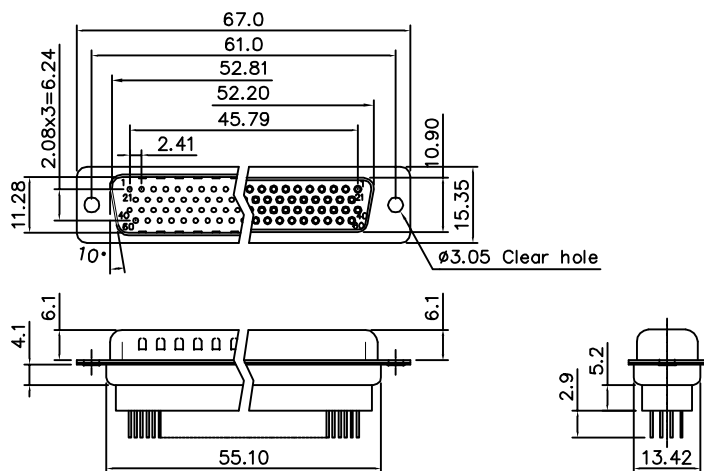

Dimensions

| Positions | A | B | C | D | E | F |
|-----------|-------|-------|-------|-------|------|-------|
| 15 | 30.81 | 24.99 | 16.92 | 16.33 | 2.29 | 19.20 |
| 26 | 39.20 | 33.30 | 25.25 | 24.70 | 2.29 | 27.70 |
| 44 | 53.05 | 47.04 | 38.96 | 38.40 | 2.29 | 41.10 |
| 62 | 69.40 | 63.50 | 55.42 | 54.80 | 2.41 | 57.30 |



78 Positions

DO NOT SCALE DRAWING

| | | |
|--|--|--|
| DIMENSIONS: <input type="checkbox"/> MM [INCH] <input type="checkbox"/> INCH [mm] <input checked="" type="checkbox"/> MM ONLY | CAD GENERATED DRAWING, DO NOT MANUALLY UPDATE DRAWN BY AND DATE JUSTIN XING 07-03-06 |  Y-S ELECTRONIC CO., LTD. No. 101, Sec. 1, Long-An Street, Lu-Chu, Taoyuan, Taiwan, R.O.C. TEL: +886-3-3609819 FAX: +886-3-3609817 |
| | | |
| MATERIAL: _____ FINISH: _____ | CHECKED BY AND DATE JUSTIN XING 07-03-06 APPROVED BY AND DATE KING CHIU 07-03-06 THIRD ANGLE PROJECTION  | TITLE 160 SERIES D-SUB H.D. HIGH PROFILE PCB TYPE |
| SCALE: 1 : 1 SIZE: A3 | DRAWING NO. 160-XXXXXXXXXX | REV A |
| FILE NO.: _____ | SHEET 1 OF 4 | |

THE INFORMATION CONTAINED IN THIS DOCUMENT IS PROPRIETARY TO Y-S ELECTRONIC, ANY REPRODUCTION IN PART OR WHOLE WITHOUT PRIOR WRITTEN APPROVAL OR AUTHORIZATION OF Y-S ELECTRONIC IS STRICTLY PROHIBITED.

RoHS COMPLIANT

Ordering Information

160 - $\frac{XX}{a} \frac{X}{b} \frac{X}{c} \frac{X}{d} \frac{X}{e} \frac{X}{f} \frac{X}{g} \frac{X}{h} \frac{X}{i}$

| REVISIONS | | | | |
|-----------|---------|-------------|-------------|------|
| REV | ECN NO. | DESCRIPTION | APPROVED BY | DATE |
| | | | | |

a. No. Of Contacts:

- 15: 15 positions
- 26: 26 positions
- 44: 44 positions
- 62: 62 positions
- 78: 78 positions

b. Contact Type

- 1: Male
- 2: Female

c. Contact Plating

- 0: Gold flash selective gold(standard)
- 1: 5u" selective gold on contact
- 2: 10u" selective gold on contact
- 3: 15u" selective gold on contact
- 4: 30u" selective gold on contact
- 5: 50u" selective gold on contact
- 6: Full gold flash

d. Shell plating :

- 0. Cr yellow chrome
- 1. Nickel(standard)
- 2. Tin
- 3. Cr yellow chrome
- 4. Gold flash
- 5. Special tin, dimple
- 6. Tin, L type
- 7. Tin(With Y-S Logo)

e. Rivet Options :

- 0:Clear hole ϕ 3.05mm
- 1:Rivet front 5.9mm
- 2:Rear rivet, 5.9mm
- 3:Standoff+2 prong boardlock11.0*3.0mm
- 4:Standoff+4prong boardlock11.0*3.0mm
- 5:Standoff+2prong boardlock12.0*3.2mm
- 6:Standoff+2prong boardlock14.5*3.0mm
- 7:Standoff+2prong boardlock10.5*3.0mm
- A:Front rivet,2.0mm
- B:Front rivet,2.5mm
- C:Front rivet,4.0mm
- D:Rear rivet, 2.0mm
- E:Rear rivet, 2.5mm
- F:Rear rivet, 4.0mm
- G:Standoff+2 prong boardlock11.7*3.0mm
- H:Standoff+2 prong boardlock11.9*3.2mm
- I:Standoff+2 prong boardlock13.5*3.2mm
- J:Standoff+2 prong boardlock14.2*3.0mm
- K:Standoff+2 prong boardlock10.0*3.2mm
- L:Standoff+2 prong boardlock10.6*3.2mm
- M:Standoff+2 prong boardlock9.0*3.0mm
- N:Standoff+2 prong boardlock9.6*3.2mm
- P:Standoff+2 prong boardlock12.7*3.0mm
- Q:Rear rivet, 12.0mm
- R:Standoff+2 prong boardlock14.2*3.2mm (cut 1.0mm)

f. Flange Mounting Option :

- 0: ϕ 3.05mm clear hole
- 1:#4-40 threaded hole

- 2:#4-40 threaded hole with #4-40 unc(5.8*11.8mm)screwlock installed
- 3:#4-40 threaded hole with #4-40 unc(5.8*11.8mm)screwlock bulk-packed
- 4:M3 threaded hole
- 5:#4-40 threaded hole with M3(5.8*11.8mm)screwlock installed
- 6:M2.6 threaded hole
- 7:#4-40 threaded hole with M2.6(5.8*11.8mm)screwlock installed
- 8:#4-40 threaded hole with M2.6(5.8*11.8mm)screwlock bulk-packed
- 9:#4-40 threaded hole with #4-40 unc(4.8*11.8mm)screwlock installed
- A:#4-40 threaded hole with #4-40 unc(5.8*10.8mm)screwlock bulk-packed
- B:#4-40 threaded hole with #4-40 unc(5.8*10.8mm)screwlock installed
- C:#4-40 threaded hole with M3(5.8*10.8mm)screwlock installed
- D:#4-40 threaded hole with #4-40 unc(5.8*10.8mm)"-" font screwlock bulk-packed
- E:#4-40 threaded hole with #4-40 unc(4.8*11.8mm)screwlock bulk-packed
- F:#4-40 threaded hole with #4-40 unc(5.8*10.8mm)"-" font screwlock installed

g. Contact Type :

- 1:Stamped pin:5.4mm
- 2:Machined pin:5.4mm
- 3:Stamped pin:3.6mm
- 4:Stamped pin:7.2mm
- 5:Machined pin:7.5mm
- 6:Stamped pin:2.5mm
- 7:Stamped pin:3.0mm(brass)
- 8:Machined pin:3.6mm
- 9:Stamped pin:4.1mm(brass)
- 0:Stamped pin:3.0mm(brass)



h. Ferrite :

- 0. Without ferrite
- 1. With ferrite

i. Insulator Color

- 1:Blue
- 2:Black
- 3:Up blue below Black

DO NOT SCALE DRAWING

| | | | | | |
|---|--|---|-------|--|--|
| DIMENSIONS: <input type="checkbox"/> MM [INCH] <input type="checkbox"/> INCH [MM] <input checked="" type="checkbox"/> MM ONLY | | CAD GENERATED DRAWING, DO NOT MANUALLY UPDATE DRAWN BY AND DATE JUSTIN XING 17-20-06 | |  Y-S ELECTRONIC CO., LTD. No. 101, Sec. 1, Long-An Street, Lu-Chu, Taoyuan, Taiwan, R.O.C. TEL: +886-3-3609819 FAX: +886-3-3609817 | |
| UNLESS OTHERWISE SPECIFIED, GENERAL TOLERANCE: DECIMALS ANGLES X: ± 0.38 [0.015] X° $\pm 3^\circ$.X ± 0.25 [0.010] .X° $\pm 1.0^\circ$.XX ± 0.13 [0.005] | | CHECKED BY AND DATE JUSTIN XING 07-20-06 APPROVED BY AND DATE KING CHIU 07-20-06 THIRD ANGLE PROJECTION | | | |
| MATERIAL | |  | | TITLE 160 SERIES D-SUB H.D. HIGH PROFILE PCB TYPE | |
| FINISH | | SCALE: 1:1 SIZE: A3 | | | |
| DRAWING NO. 160-XXXXXXXXXX | | | REV D | | |
| FILE NO.: | | | | SHEET 2 OF 4 | |

THE INFORMATION CONTAINED IN THIS DOCUMENT IS PROPRIETARY TO Y-S ELECTRONIC. ANY REPRODUCTION IN PART OR WHOLE WITHOUT PRIOR WRITTEN APPROVAL OR AUTHORIZATION OF Y-S ELECTRONIC IS STRICTLY PROHIBITED.

RoHS COMPLIANT

| REVISIONS | | | | |
|-----------|---------|-------------|-------------|------|
| REV | ECN NO. | DESCRIPTION | APPROVED BY | DATE |
| A | | | | |

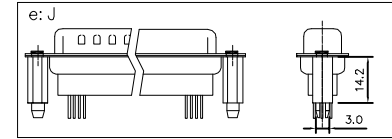
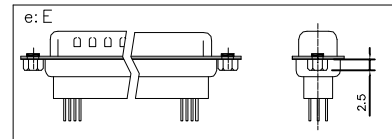
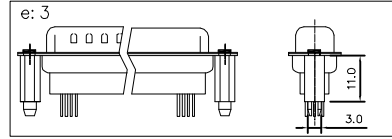
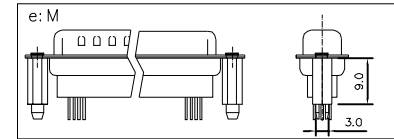
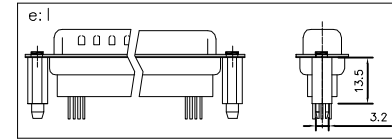
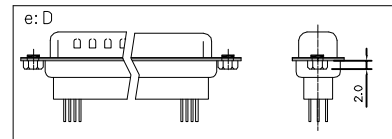
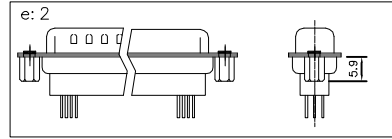
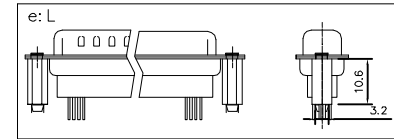
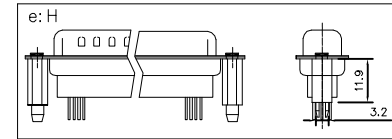
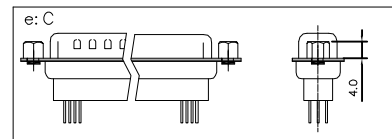
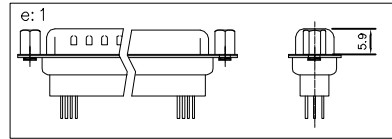
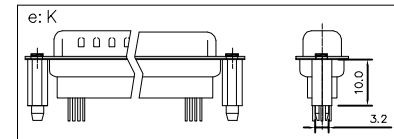
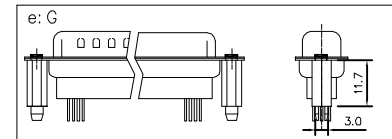
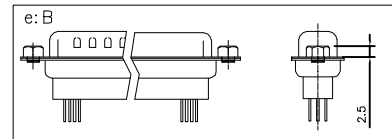
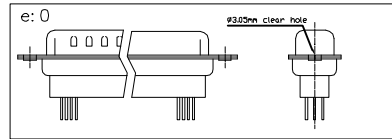

CONSULT SALES OR
FACTORY FOR OTHER
MOUNTING STYLE OPTIONS

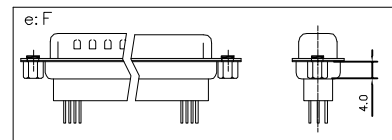
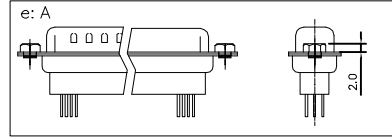

DO NOT SCALE DRAWING

DIMENSIONS:
 MM [INCH] INCH [mm] MM ONLY

UNLESS OTHERWISE SPECIFIED,
GENERAL TOLERANCE:
 DECIMALS ANGLES
 X: ±0.38 [0.015] X°: ±3°
 .X: ±0.25 [0.010] .X°: ±1.0°
 .XX: ±0.13 [0.005]

MATERIAL
FINISH

CAD GENERATED DRAWING,
DO NOT MANUALLY UPDATE
 DRAWN BY AND DATE
 JUSTIN XING 07-03-06

CHECKED BY AND DATE
 JUSTIN XING 07-03-06
 APPROVED BY AND DATE
 KING CHIU 07-03-06
 THIRD ANGLE PROJECTION

SCALE:
1 : 1 SIZE: A3

 **Y-S ELECTRONIC CO., LTD.**
 No. 101, Sec. 1, Long-An Street,
 Lu-Chu, Taoyuan, Taiwan, R.O.C.
 TEL: +886-3-3609819 FAX: +886-3-3609817

TITLE
 160 SERIES
 D-SUB H.D. HIGH PROFILE PCB
 TYPE

DRAWING NO.
 160-XXXXXXXXX REV
 A

FILE NO. SHEET 3 OF 4

THE INFORMATION CONTAINED IN THIS DOCUMENT IS PROPRIETARY TO Y-S ELECTRONIC. ANY REPRODUCTION IN PART OR WHOLE WITHOUT PRIOR WRITTEN APPROVAL OR AUTHORIZATION OF Y-S ELECTRONIC IS STRICTLY PROHIBITED.

RoHS COMPLIANT

| REVISIONS | | | | |
|-----------|---------|-------------|-------------|------|
| REV | ECN NO. | DESCRIPTION | APPROVED BY | DATE |
| | | | | |

P.C.B LAYOUT PATTERN

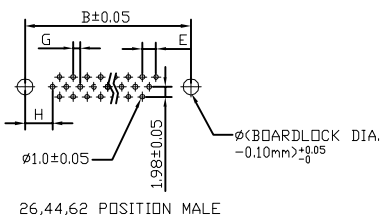
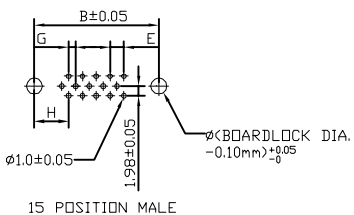
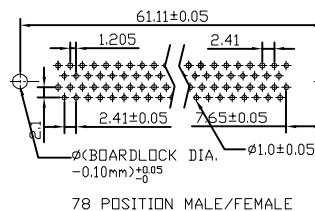
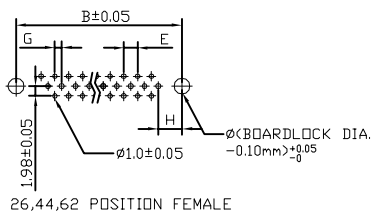
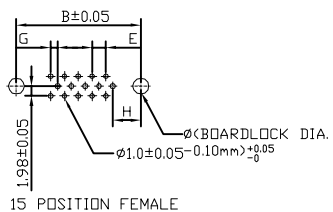

| Positions | G | H |
|-----------|-------|------|
| 15M/F | 1.145 | 7.04 |
| 26M/F | 1.145 | 6.88 |
| 44M/F | 1.145 | 6.88 |
| 62M/F | 1.205 | 7.00 |

DO NOT SCALE DRAWING

DIMENSIONS:
 MM [INCH] INCH [mm] MM ONLY

UNLESS OTHERWISE SPECIFIED, GENERAL TOLERANCE:
 DECIMALS ANGLES
 X. ±0.38 [0.015] X° ±3°
 .X ±0.25 [0.010] .X° ±1.0°
 .XX ±0.13 [0.005]

MATERIAL
 FINISH

CAD GENERATED DRAWING, DO NOT MANUALLY UPDATE
 DRAWN BY AND DATE
 JUSTIN XING 07-03-06

CHECKED BY AND DATE
 JUSTIN XING 07-03-06
 APPROVED BY AND DATE
 KING CHIU 07-03-06
 THIRD ANGLE PROJECTION



SCALE: 1 : 1 SIZE: A3



Y-S ELECTRONIC CO., LTD.
 No. 101, Sec. 1, Long-An Street,
 Lu-Chu, Taoyuan, Taiwan, R.O.C.
 TEL: +886-3-3609819 FAX: +886-3-3609817

TITLE
 160 SERIES
 D-SUB H.D. HIGH PROFILE PCB
 TYPE

DRAWING NO.
 160-XXXXXXXXXX

FILE NO. SHEET 4 OF 4