

THE INFORMATION CONTAINED IN THIS DOCUMENT IS PROPRIETARY TO Y-S ELECTRONIC, ANY REPRODUCTION IN PART OR WHOLE WITHOUT PRIOR WRITTEN APPROVAL OR AUTHORIZATION OF Y-S ELECTRONIC IS STRICTLY PROHIBITED.

RoHS COMPLIANT

REVISIONS				
REV	ECN NO.	DESCRIPTION	APPROVED BY	DATE

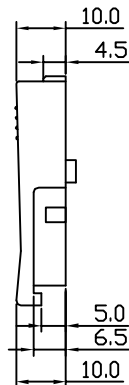
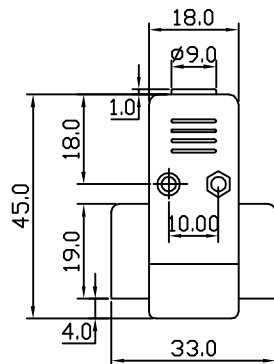

Product Specification

Material

- Hood :ABS thermoplastic UL94V-0 rates
- UL94V-0 rates
- Screwlock :Steel, 100u" min Nickel Plated.

Ordering Information

156 - $\frac{XX}{a} \frac{X}{b} \frac{X}{c} \frac{X}{d}$

- a. No. Of Pins
- b. Shell Type
 - 0: Plastic
 - 1: Nickel plate metalized
- c. Screw Type
 - 1: Short screws with #4-40 unc
 - 2: Long screws with #4-40 unc
 - 3: Short screws with M3
 - 4: Long screws with M3
- d. Insulator Color
 - 1: Black
 - 2: Gray
 - 3: Platinum

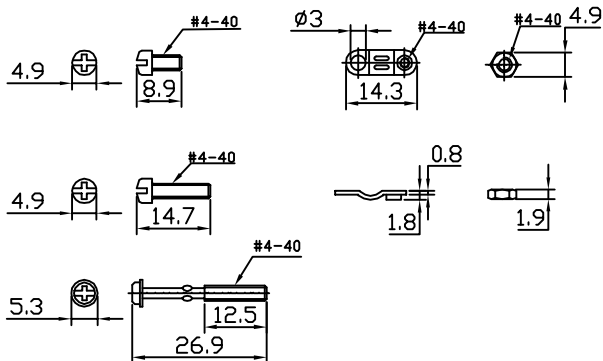
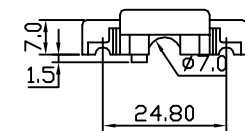

Short Screw type
09pin type only

DIMENSIONS: <input type="checkbox"/> MM [INCH] <input type="checkbox"/> INCH [mm] <input checked="" type="checkbox"/> MM ONLY	CAD GENERATED DRAWING, DO NOT MANUALLY UPDATE DRAWN BY AND DATE JUSTIN XING 07-03-06	Y-S ELECTRONIC CO., LTD. No. 101, Sec. 1, Long-An Street, Lu-Chu, Taoyuan, Taiwan, R.O.C. TEL: +886-3-3609819 FAX: +886-3-3609817	TITLE	
			156 SERIES D-SUB COVER	
UNLESS OTHERWISE SPECIFIED, GENERAL TOLERANCE: DECIMALS ANGLES X: ±0.38 [0.015] X°: ±3° .X: ±0.25 [0.010] .X°: ±1.0° .XX: ±0.13 [0.005]	CHECKED BY AND DATE JUSTIN XING 07-03-06 APPROVED BY AND DATE KING CHIU 07-03-06 THIRD ANGLE PROJECTION	DRAWING NO. 156-09X1X	REV	SHEET 1 OF 10
			SCALE: 1 : 1 SIZE: A3	
MATERIAL		FILE NO.		
FINISH				

DO NOT SCALE DRAWING

THE INFORMATION CONTAINED IN THIS DOCUMENT IS PROPRIETARY TO Y-S ELECTRONIC. ANY REPRODUCTION IN PART OR WHOLE WITHOUT PRIOR WRITTEN APPROVAL OR AUTHORIZATION OF Y-S ELECTRONIC IS STRICTLY PROHIBITED.

RoHS COMPLIANT

REVISIONS				
REV	ECN NO.	DESCRIPTION	APPROVED BY	DATE

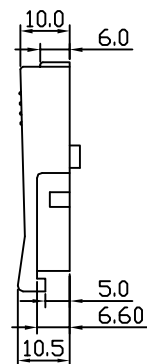
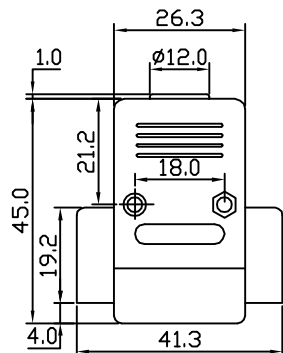

Product Specification

Material

Hood :ABS thermoplastic UL94V-0 rates
 UL94V-0 rates
 Screwlock :Steel, 100u" min Nickel Plated.

Ordering Information

156 - $\frac{XX}{a} \frac{X}{b} \frac{X}{c} \frac{X}{d}$

- a. No. Of Pins
- b. Shell Type
 - 0: Plastic
 - 1: Nickel plate metalized
- c. Screw Type
 - 1: Short screws with #4-40 unc
 - 2: Long screws with #4-40 unc
 - 3: Short screws with M3
 - 4: Long screws with M3
- d. Insulator Color
 - 1: Black
 - 2: Gray
 - 3: Platinum

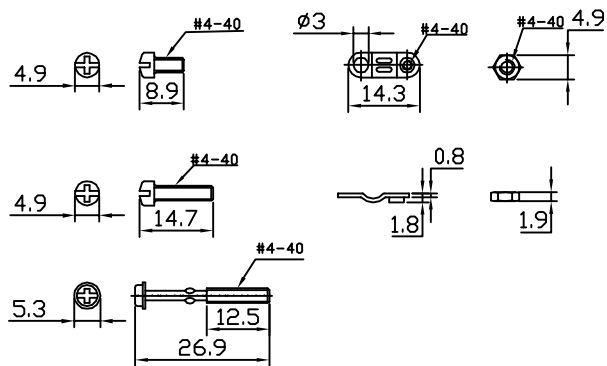
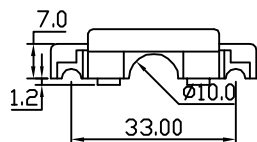

Short Screw type
 15pin type only

DIMENSIONS:	
<input type="checkbox"/> MM [INCH]	<input type="checkbox"/> INCH [mm]
<input type="checkbox"/> MM ONLY	<input checked="" type="checkbox"/> MM ONLY

UNLESS OTHERWISE SPECIFIED, GENERAL TOLERANCE:	CHECKED BY AND DATE JUSTIN XING 07-03-06
DECIMALS X: ±0.38 [0.015] .X: ±0.25 [0.010] .XX: ±0.13 [0.005]	APPROVED BY AND DATE KING CHIU 07-03-06
ANGLES X°: ±3° .X°: ±1.0°	THIRD ANGLE PROJECTION

MATERIAL	
FINISH	
SCALE: 1:1	SIZE: A3

CAD GENERATED DRAWING, DO NOT MANUALLY UPDATE
 DRAWN BY AND DATE
 JUSTIN XING 07-03-06



Y-S ELECTRONIC CO., LTD.
 No. 101, Sec. 1, Long-An Street,
 Lu-Chu, Taoyuan, Taiwan, R.O.C.
 TEL: +886-3-3609819 FAX: +886-3-3609817

TITLE	156 SERIES D-SUB COVER
DRAWING NO.	156-15X1X
REV	A

FILE NO.	SHEET 2 OF 10
----------	---------------

DO NOT SCALE DRAWING

THE INFORMATION CONTAINED IN THIS DOCUMENT IS PROPRIETARY TO Y-S ELECTRONIC. ANY REPRODUCTION IN PART OR WHOLE WITHOUT PRIOR WRITTEN APPROVAL OR AUTHORIZATION OF Y-S ELECTRONIC IS STRICTLY PROHIBITED.

RoHS COMPLIANT

REVISIONS				
REV	ECN NO.	DESCRIPTION	APPROVED BY	DATE
A				2005-10-27

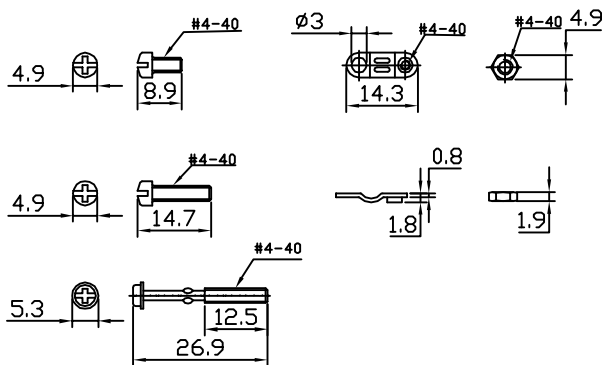
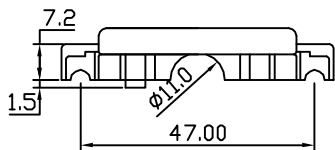
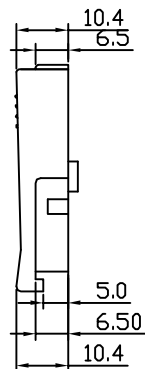
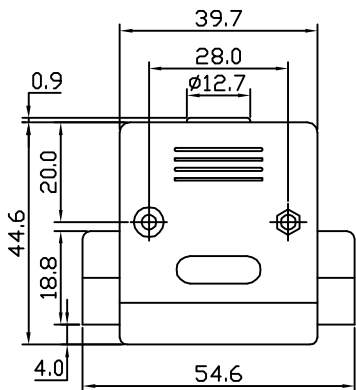

Short Screw type
25pin type only

Product Specification

Material



Hood :ABS thermoplastic UL94V-0 rates
UL94V-0 rates
Screwlock :Steel, 100u" min Nickel Plated.

Ordering Information

156 - $\frac{XX}{a} \frac{X}{b} \frac{X}{c} \frac{X}{d}$

- a. No. Of Pins
- b. Shell Type
 - 0: Plastic
 - 1: Nickel plate metalized
- c. Screw Type
 - 1: Short screws with #4-40 unc
 - 2: Long screws with #4-40 unc
 - 3: Short screws with M3
 - 4: Long screws with M3
- d. Insulator Color
 - 1: Black
 - 2: Gray
 - 3: Platinum

DO NOT SCALE DRAWING

DIMENSIONS: <input type="checkbox"/> MM [INCH] <input type="checkbox"/> INCH [mm] <input checked="" type="checkbox"/> MM ONLY	CAD GENERATED DRAWING, DO NOT MANUALLY UPDATE	 Y-S ELECTRONIC CO., LTD. No. 101, Sec. 1, Long-An Street, Lu-Chu, Taoyuan, Taiwan, R.O.C. TEL: +886-3-3609819 FAX: +886-3-3609817	
	UNLESS OTHERWISE SPECIFIED, GENERAL TOLERANCE: DECIMALS ANGLES X: ±0.38 [0.015] X° ±3° .X ±0.25 [0.010] .X° ±1.0° .XX ±0.13 [0.005]		DRAWN BY AND DATE JUSTIN XING 07-03-06
MATERIAL	CHECKED BY AND DATE JUSTIN XING 07-03-06	DRAWING NO. 156-25X1X	
FINISH	APPROVED BY AND DATE KING CHIU 07-03-06		REV A
	THIRD ANGLE PROJECTION 	FILE NO.	SHEET 3 OF 10
	SCALE: 1 : 1	SIZE: A3	

THE INFORMATION CONTAINED IN THIS DOCUMENT IS PROPRIETARY TO Y-S ELECTRONIC. ANY REPRODUCTION IN PART OR WHOLE WITHOUT PRIOR WRITTEN APPROVAL OR AUTHORIZATION OF Y-S ELECTRONIC IS STRICTLY PROHIBITED.

RoHS COMPLIANT

REVISIONS				
REV	ECN NO.	DESCRIPTION	APPROVED BY	DATE

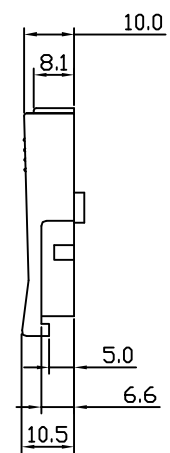
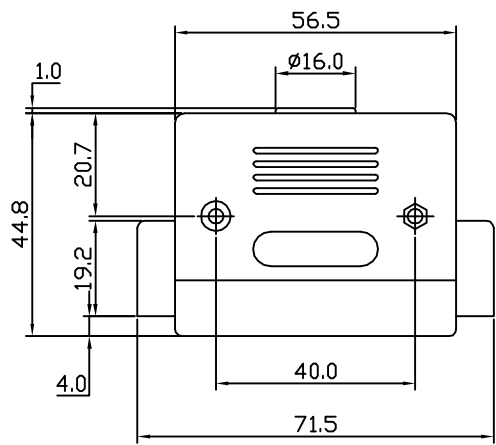

Product Specification

Material
 Hood :ABS thermoplastic UL94V-0 rates
 UL94V-0 rates
 Screwlock :Steel, 100u" min Nickel Plated.
 Plated.

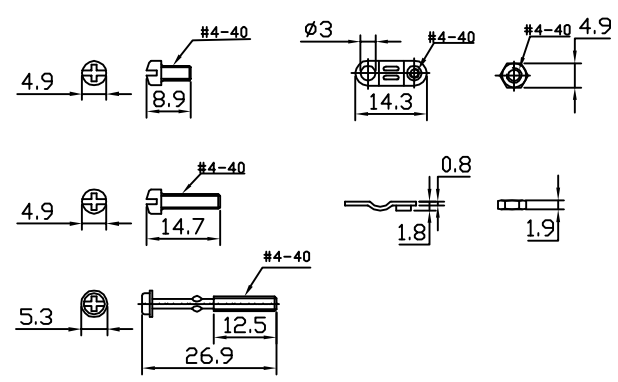
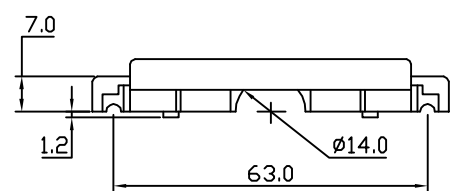

Short Screw type
 37pin type only

Ordering Information

$$156 - \frac{XX}{a} \frac{X}{b} \frac{X}{c} \frac{X}{d}$$

- a. No. Of Pins
- b. Shell Type
 - 0: Plastic
 - 1: Nickel plate metalized
- c. Screw Type
 - 1: Short screws with #4-40 unc
 - 2: Long screws with #4-40 unc
 - 3: Short screws with M3
 - 4: Long screws with M3
- d. Insulator Color
 - 1: Black
 - 2: Gray
 - 3: Platinum

DO NOT SCALE DRAWING

DIMENSIONS: <input type="checkbox"/> MM [INCH] <input type="checkbox"/> INCH [mm] <input checked="" type="checkbox"/> MM ONLY	CAD GENERATED DRAWING, DO NOT MANUALLY UPDATE	Y-S ELECTRONIC CO., LTD. No. 101, Sec. 1, Long-An Street, Lu-Chu, Taoyuan, Taiwan, R.O.C. TEL: +886-3-3609819 FAX: +886-3-3609817		
	UNLESS OTHERWISE SPECIFIED, GENERAL TOLERANCE: DECIMALS ANGLES X: ±0.38 [0.015] X° ±3° .X ±0.25 [0.010] .X° ±1.0° .XX ±0.13 [0.005]		DRAWN BY AND DATE JUSTIN XING 07-03-06	TITLE 156 SERIES D-SUB COVER
MATERIAL	CHECKED BY AND DATE KING CHIU 07-03-06	APPROVED BY AND DATE KING CHIU 07-03-06		
FINISH	THIRD ANGLE PROJECTION 		DRAWING NO. 156-37X1X	REV A
SCALE: 1 : 1	SIZE: A3	FILE NO.:	SHEET 4 OF 10	

THE INFORMATION CONTAINED IN THIS DOCUMENT IS PROPRIETARY TO Y-S ELECTRONIC, ANY REPRODUCTION IN PART OR WHOLE WITHOUT PRIOR WRITTEN APPROVAL OR AUTHORIZATION OF Y-S ELECTRONIC IS STRICTLY PROHIBITED.

RoHS COMPLIANT

REVISIONS				
REV	ECN NO.	DESCRIPTION	APPROVED BY	DATE

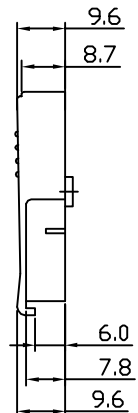
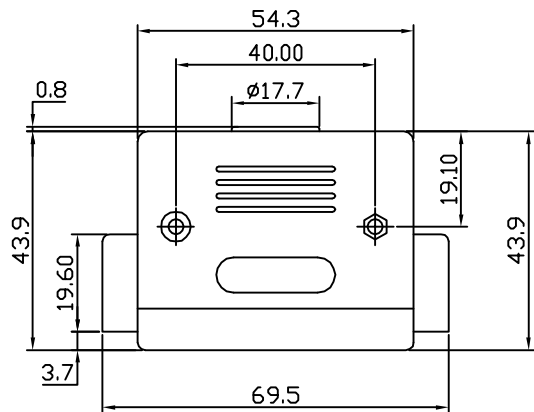

Product Specification

Material

Hood :ABS thermoplastic UL94V-0 rates
 UL94V-0 rates
 Screwlock :Steel, 100u" min Nickel Plated.

Ordering Information

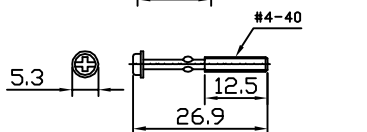
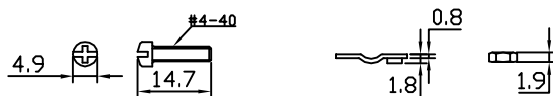
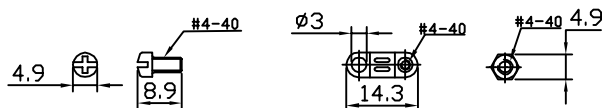
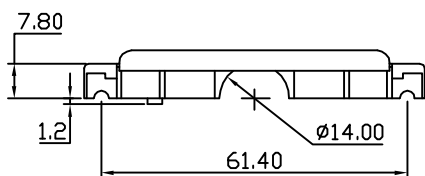

156 - $\frac{XX}{a} \frac{X}{b} \frac{X}{c} \frac{X}{d}$

- a. No. Of Pins
- b. Shell Type
 - 0: Plastic
 - 1: Nickel plate metalized
- c. Screw Type
 - 1: Short screws with #4-40 unc
 - 2: Long screws with #4-40 unc
 - 3: Short screws with M3
 - 4: Long screws with M3
- d. Insulator Color
 - 1: Black
 - 2: Gray
 - 3: Platinum



Short Screw type
50pin type only

DO NOT SCALE DRAWING

DIMENSIONS: <input type="checkbox"/> MM [INCH] <input type="checkbox"/> INCH [mm] <input checked="" type="checkbox"/> MM ONLY	CAD GENERATED DRAWING, DO NOT MANUALLY UPDATE	 Y-S ELECTRONIC CO., LTD. No. 101, Sec. 1, Long-An Street, Lu-Chu, Taoyuan, Taiwan, R.O.C. TEL: +886-3-3609819 FAX: +886-3-3609817	
	UNLESS OTHERWISE SPECIFIED, GENERAL TOLERANCE: DECIMALS ANGLES X: ±0.38 [0.015] X° ±3° .X ±0.25 [0.010] .X° ±1.0° .XX ±0.13 [0.005]		DRAWN BY AND DATE JUSTIN XING 07-03-06
MATERIAL	CHECKED BY AND DATE JUSTIN XING 07-03-06	APPROVED BY AND DATE KING CHIU 07-03-06	
FINISH	THIRD ANGLE PROJECTION 		DRAWING NO. 156-50X1X
SCALE: 1 : 1 SIZE: A3		FILE NO.:	SHEET 5 OF 10

THE INFORMATION CONTAINED IN THIS DOCUMENT IS PROPRIETARY TO Y-S ELECTRONIC, ANY REPRODUCTION IN PART OR WHOLE WITHOUT PRIOR WRITTEN APPROVAL OR AUTHORIZATION OF Y-S ELECTRONIC IS STRICTLY PROHIBITED.

RoHS COMPLIANT

REVISIONS				
REV	ECN NO.	DESCRIPTION	APPROVED BY	DATE

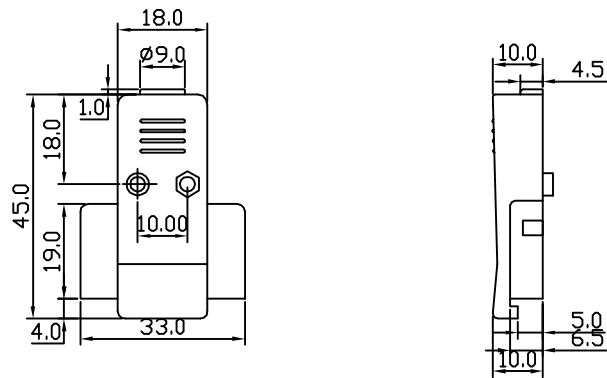

Product Specification

Material

Hood :ABS thermoplastic UL94V-0 rates
 UL94V-0 rates
 Screwlock :Steel, 100u" min Nickel Plated.

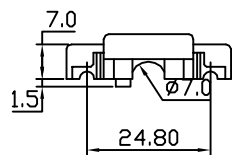



Ordering Information

156 - $\frac{XX}{a} \frac{X}{b} \frac{X}{c} \frac{X}{d}$

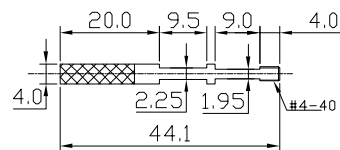
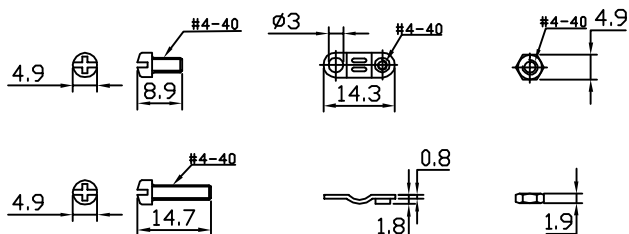
- a. No. Of Pins
- b. Shell Type
 - 0: Plastic
 - 1: Nickel plate metalized
- c. Screw Type
 - 1: Short screws with #4-40 unc
 - 2: Long screws with #4-40 unc
 - 3: Short screws with M3
 - 4: Long screws with M3
- d. Insulator Color
 - 1: Black
 - 2: Gray
 - 3: Platinum



Long Screw type
 09pin type only

DIMENSIONS: <input type="checkbox"/> MM [INCH] <input type="checkbox"/> INCH [mm] <input checked="" type="checkbox"/> MM ONLY	CAD GENERATED DRAWING, DO NOT MANUALLY UPDATE	 Y-S ELECTRONIC CO., LTD. No. 101, Sec. 1, Long-An Street, Lu-Chu, Taoyuan, Taiwan, R.O.C. TEL: +886-3-3609819 FAX: +886-3-3609817
	DRAWN BY AND DATE JUSTIN XING 07-03-06	
UNLESS OTHERWISE SPECIFIED, GENERAL TOLERANCE: DECIMALS ANGLES .X ±0.38 [0.015] X° ±3° .X ±0.25 [0.010] .X° ±1.0° .XX ±0.13 [0.005]	CHECKED BY AND DATE JUSTIN XING 07-03-06	DRAWING NO. 156-09X2X
MATERIAL	APPROVED BY AND DATE KING CHIU 07-03-06	REV A
FINISH	THIRD ANGLE PROJECTION 	FILE NO.
SCALE: 1 : 1	SIZE: A3	SHEET 6 OF 10

DO NOT SCALE DRAWING

THE INFORMATION CONTAINED IN THIS DOCUMENT IS PROPRIETARY TO Y-S ELECTRONIC, ANY REPRODUCTION IN PART OR WHOLE WITHOUT PRIOR WRITTEN APPROVAL OR AUTHORIZATION OF Y-S ELECTRONIC IS STRICTLY PROHIBITED.

RoHS COMPLIANT

REVISIONS				
REV	ECN NO.	DESCRIPTION	APPROVED BY	DATE

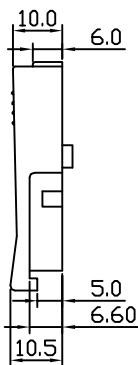
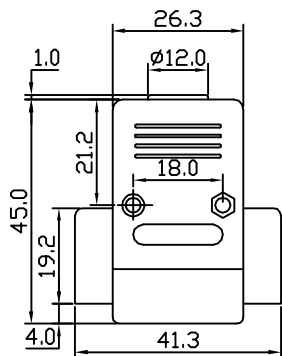

Product Specification

Material

- Hood :ABS thermoplastic UL94V-0 rates
- UL94V-0 rates
- Screwlock :Steel, 100u" min Nickel Plated.

Ordering Information

156 - $\frac{XX}{a} \frac{X}{b} \frac{X}{c} \frac{X}{d}$

- a. No. Of Pins
- b. Shell Type
 - 0: Plastic
 - 1: Nickel plate metalized
- c. Screw Type
 - 1: Short screws with #4-40 unc
 - 2: Long screws with #4-40 unc
 - 3: Short screws with M3
 - 4: Long screws with M3
- d. Insulator Color
 - 1: Black
 - 2: Gray
 - 3: Platinum

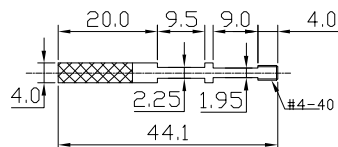
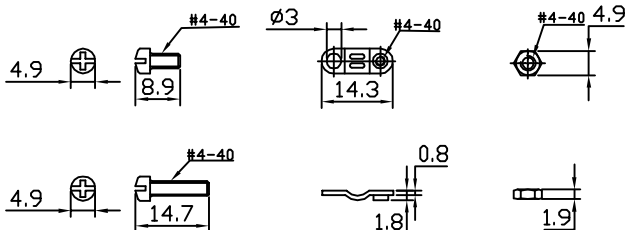
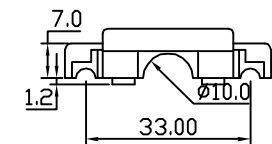

Long Screw type
15pin type only

DO NOT SCALE DRAWING

DIMENSIONS: <input type="checkbox"/> MM [INCH] <input type="checkbox"/> INCH [mm] <input checked="" type="checkbox"/> MM ONLY	CAD GENERATED DRAWING, DO NOT MANUALLY UPDATE	Y-S ELECTRONIC CO., LTD. No. 101, Sec. 1, Long-An Street, Lu-Chu, Taoyuan, Taiwan, R.O.C. TEL: +886-3-3609819 FAX: +886-3-3609817	
	DRAWN BY AND DATE JUSTIN XING 07-03-06		TITLE 156 SERIES D-SUB COVER
UNLESS OTHERWISE SPECIFIED, GENERAL TOLERANCE: DECIMALS ANGLES X: ±0.38 [0.015] X°: ±3° .X: ±0.25 [0.010] .X°: ±1.0° .XX: ±0.13 [0.005]	CHECKED BY AND DATE JUSTIN XING 07-03-06	DRAWING NO. 156-15X2X	
MATERIAL	APPROVED BY AND DATE KING CHIU 07-03-06		REV A
FINISH	THIRD ANGLE PROJECTION 	FILE NO.	SHEET 7 OF 10
SCALE: 1 : 1	SIZE: A3	FILE NO.	

THE INFORMATION CONTAINED IN THIS DOCUMENT IS PROPRIETARY TO Y-S ELECTRONIC, ANY REPRODUCTION IN PART OR WHOLE WITHOUT PRIOR WRITTEN APPROVAL OR AUTHORIZATION OF Y-S ELECTRONIC IS STRICTLY PROHIBITED.

RoHS COMPLIANT

REVISIONS				
REV	ECN NO.	DESCRIPTION	APPROVED BY	DATE

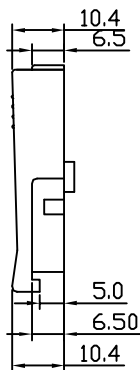
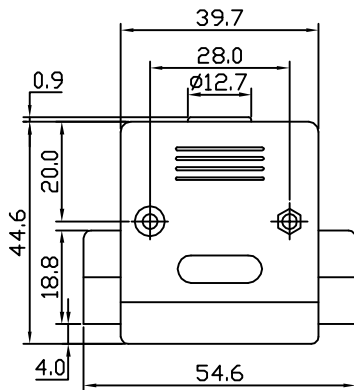

Product Specification

Material

Hood :ABS thermoplastic UL94V-0 rates
 UL94V-0 rates
 Screwlock :Steel, 100u" min Nickel Plated.

Ordering Information

156 - $\frac{XX}{a} \frac{X}{b} \frac{X}{c} \frac{X}{d}$

- a. No. Of Pins
- b. Shell Type
 - 0: Plastic
 - 1: Nickel plate metalized
- c. Screw Type
 - 1: Short screws with #4-40 unc
 - 2: Long screws with #4-40 unc
 - 3: Short screws with M3
 - 4: Long screws with M3
- d. Insulator Color
 - 1: Black
 - 2: Gray
 - 3: Platinum

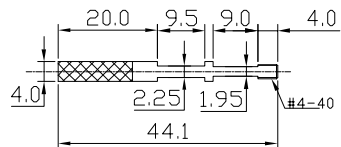
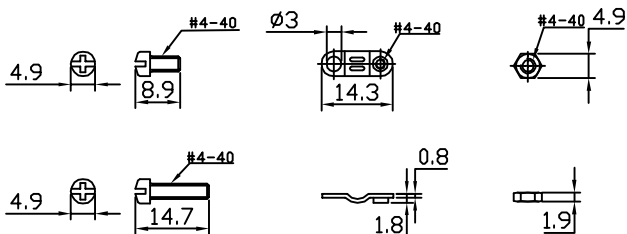
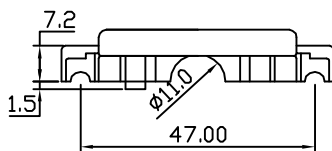

Long Screw type
 25pin type only

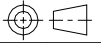
DIMENSIONS: <input type="checkbox"/> MM [INCH] <input type="checkbox"/> INCH [mm] <input checked="" type="checkbox"/> MM ONLY	CAD GENERATED DRAWING, DO NOT MANUALLY UPDATE	 Y-S ELECTRONIC CO., LTD. No. 101, Sec. 1, Long-An Street, Lu-Chu, Taoyuan, Taiwan, R.O.C. TEL: +886-3-3609819 FAX: +886-3-3609817	
	UNLESS OTHERWISE SPECIFIED, GENERAL TOLERANCE: DECIMALS ANGLES X: ±0.38 [0.015] X°: ±3° .X: ±0.25 [0.010] .X°: ±1.0° .XX: ±0.13 [0.005]		DRAWN BY AND DATE JUSTIN XING 07-03-06 CHECKED BY AND DATE JUSTIN XING 07-03-06 APPROVED BY AND DATE KING CHIU 07-03-06 THIRD ANGLE PROJECTION
MATERIAL	SCALE: 1:1 SIZE: A3		DRAWING NO. 156-25X2X REV A
FINISH			FILE NO. SHEET 8 OF 10

DO NOT SCALE DRAWING

THE INFORMATION CONTAINED IN THIS DOCUMENT IS PROPRIETARY TO Y-S ELECTRONIC, ANY REPRODUCTION IN PART OR WHOLE WITHOUT PRIOR WRITTEN APPROVAL OR AUTHORIZATION OF Y-S ELECTRONIC IS STRICTLY PROHIBITED.

RoHS COMPLIANT

REVISIONS				
REV	ECN NO.	DESCRIPTION	APPROVED BY	DATE

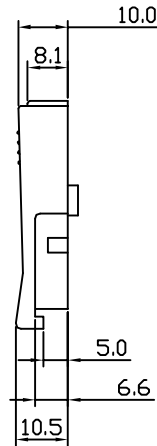
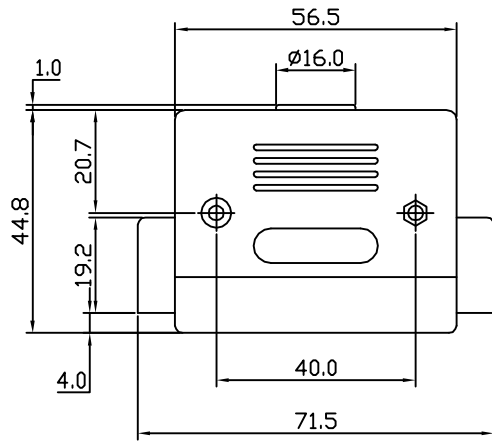

Product Specification

Material

Hood :ABS thermoplastic UL94V-0 rates
 UL94V-0 rates
 Screwlock :Steel, 100u" min Nickel Plated.

Ordering Information

156 - $\frac{XX}{a} \frac{X}{b} \frac{X}{c} \frac{X}{d}$

- a. No. Of Pins
- b. Shell Type
 - 0: Plastic
 - 1: Nickel plate metalized
- c. Screw Type
 - 1: Short screws with #4-40 unc
 - 2: Long screws with #4-40 unc
 - 3: Short screws with M3
 - 4: Long screws with M3
- d. Insulator Color
 - 1: Black
 - 2: Gray
 - 3: Platinum

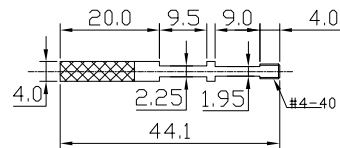
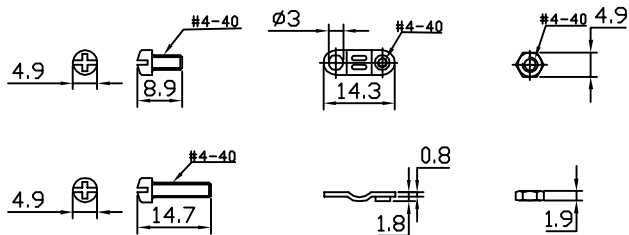
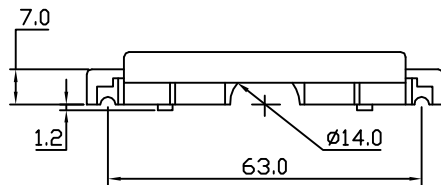

Long Screw type
 37pin type only

DO NOT SCALE DRAWING

DIMENSIONS: <input type="checkbox"/> MM [INCH] <input type="checkbox"/> INCH [mm] <input checked="" type="checkbox"/> MM ONLY	CAD GENERATED DRAWING, DO NOT MANUALLY UPDATE	Y-S ELECTRONIC CO., LTD. No. 101, Sec. 1, Long-An Street, Lu-Chu, Taoyuan, Taiwan, R.O.C. TEL: +886-3-3609819 FAX: +886-3-3609817	
	UNLESS OTHERWISE SPECIFIED, GENERAL TOLERANCE: DECIMALS ANGLES X: ±0.38 [0.015] X°: ±3° .X: ±0.25 [0.010] .X°: ±1.0° .XX: ±0.13 [0.005]		DRAWN BY AND DATE JUSTIN XING 07-03-06 CHECKED BY AND DATE JUSTIN XING 07-03-06 APPROVED BY AND DATE KING CHIU 07-03-06 THIRD ANGLE PROJECTION
MATERIAL		DRAWING NO.	REV
FINISH		SCALE: 1:1 SIZE: A3	156-37X2X
FILE NO.:		SHEET 9 OF 10	

THE INFORMATION CONTAINED IN THIS DOCUMENT IS PROPRIETARY TO Y-S ELECTRONIC, ANY REPRODUCTION IN PART OR WHOLE WITHOUT PRIOR WRITTEN APPROVAL OR AUTHORIZATION OF Y-S ELECTRONIC IS STRICTLY PROHIBITED.

RoHS COMPLIANT

REVISIONS				
REV	ECN NO.	DESCRIPTION	APPROVED BY	DATE

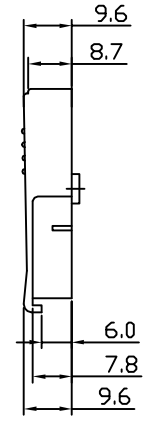
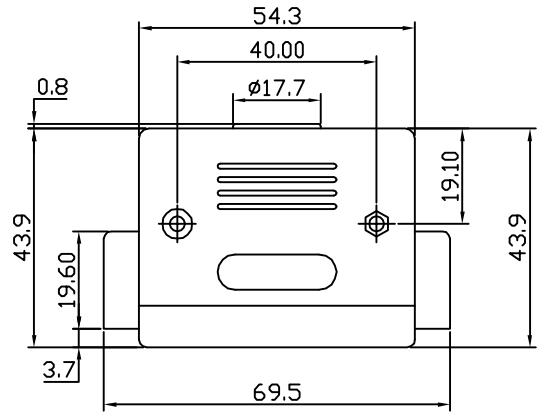

Product Specification

Material

Hood :ABS thermoplastic UL94V-0 rates
 UL94V-0 rates
 Screwlock :Steel, 100u" min Nickel Plated.

Ordering Information

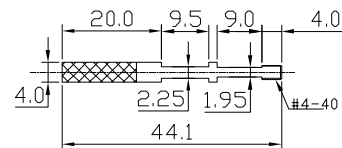
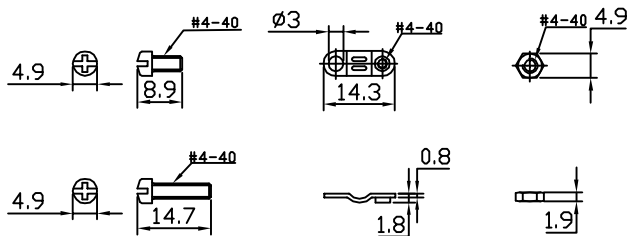
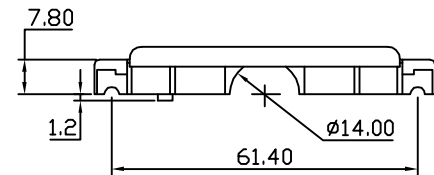

156 - $\frac{XX}{a} \frac{X}{b} \frac{X}{c} \frac{X}{d}$

- a. No. Of Pins
- b. Shell Type
 - 0: Plastic
 - 1: Nickel plate metalized
- c. Screw Type
 - 1: Short screws with #4-40 unc
 - 2: Long screws with #4-40 unc
 - 3: Short screws with M3
 - 4: Long screws with M3
- d. Insulator Color
 - 1: Black
 - 2: Gray
 - 3: Platinum



Long Screw type
50pin type only

DO NOT SCALE DRAWING

DIMENSIONS: <input type="checkbox"/> MM [INCH] <input type="checkbox"/> INCH [mm] <input checked="" type="checkbox"/> MM ONLY	CAD GENERATED DRAWING, DO NOT MANUALLY UPDATE	 Y-S ELECTRONIC CO., LTD. No. 101, Sec. 1, Long-An Street, Lu-Chu, Taoyuan, Taiwan, R.O.C. TEL: +886-3-3609819 FAX: +886-3-3609817	
	UNLESS OTHERWISE SPECIFIED, GENERAL TOLERANCE: DECIMALS ANGLES X: ±0.38 [0.015] X° ±3° .X ±0.25 [0.010] .X° ±1.0° .XX ±0.13 [0.005]		DRAWN BY AND DATE JUSTIN XING 07-03-06 CHECKED BY AND DATE JUSTIN XING 07-03-06 APPROVED BY AND DATE KING CHIU 07-03-06 THIRD ANGLE PROJECTION
MATERIAL		DRAWING NO. 156-50X2X	REV A
FINISH		SCALE: 1 : 1 SIZE: A3	FILE NO.: